

# Lecture 9

## Autonomous linear dynamical systems

- autonomous linear dynamical systems
- examples
- higher order systems
- linearization near equilibrium point
- linearization along trajectory

# Autonomous linear dynamical systems

continuous-time autonomous LDS has form

$$\dot{x} = Ax$$

- $x(t) \in \mathbf{R}^n$  is called the state
- $n$  is the *state dimension* or (informally) the *number of states*
- $A$  is the *dynamics matrix*  
(system is *time-invariant* if  $A$  doesn't depend on  $t$ )

picture (*phase plane*):

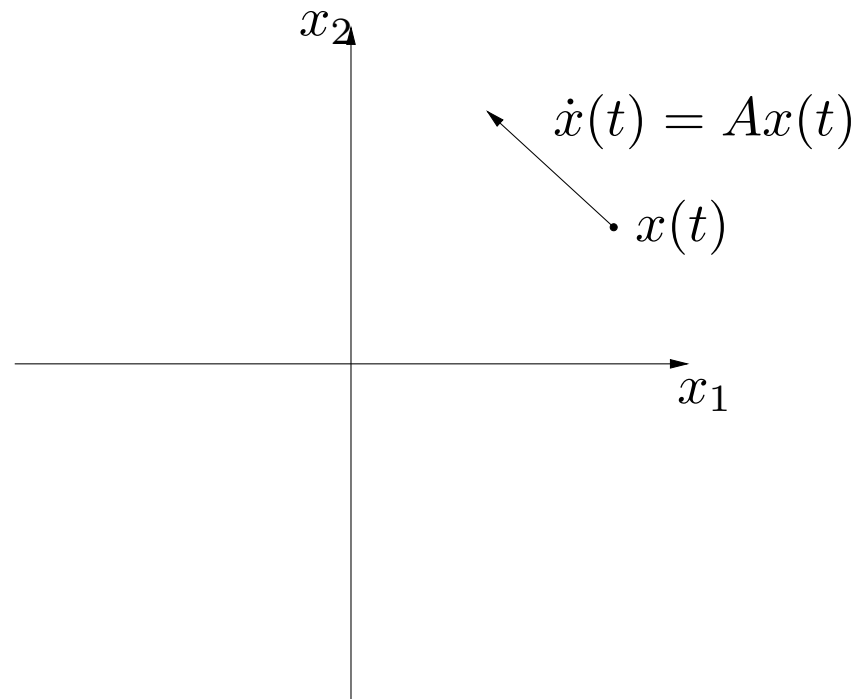

**example 1:**  $\dot{x} = \begin{bmatrix} -1 & 0 \\ 2 & 1 \end{bmatrix} x$

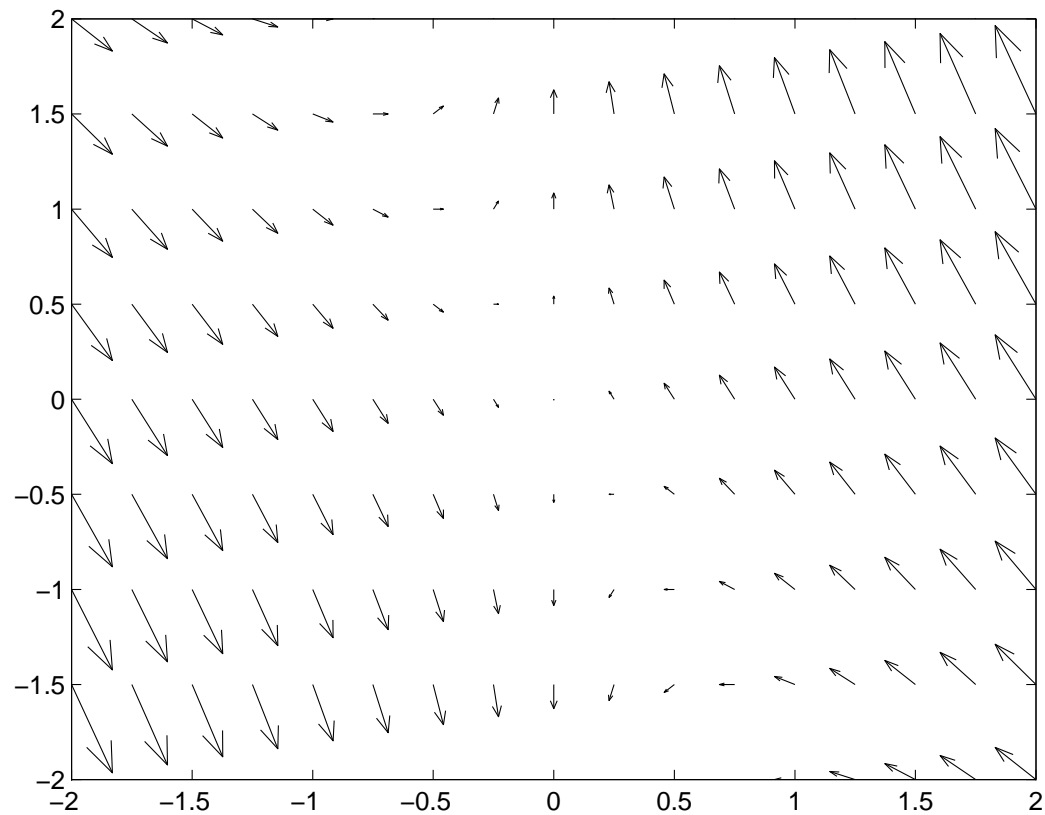

**example 2:**  $\dot{x} = \begin{bmatrix} -0.5 & 1 \\ -1 & 0.5 \end{bmatrix} x$

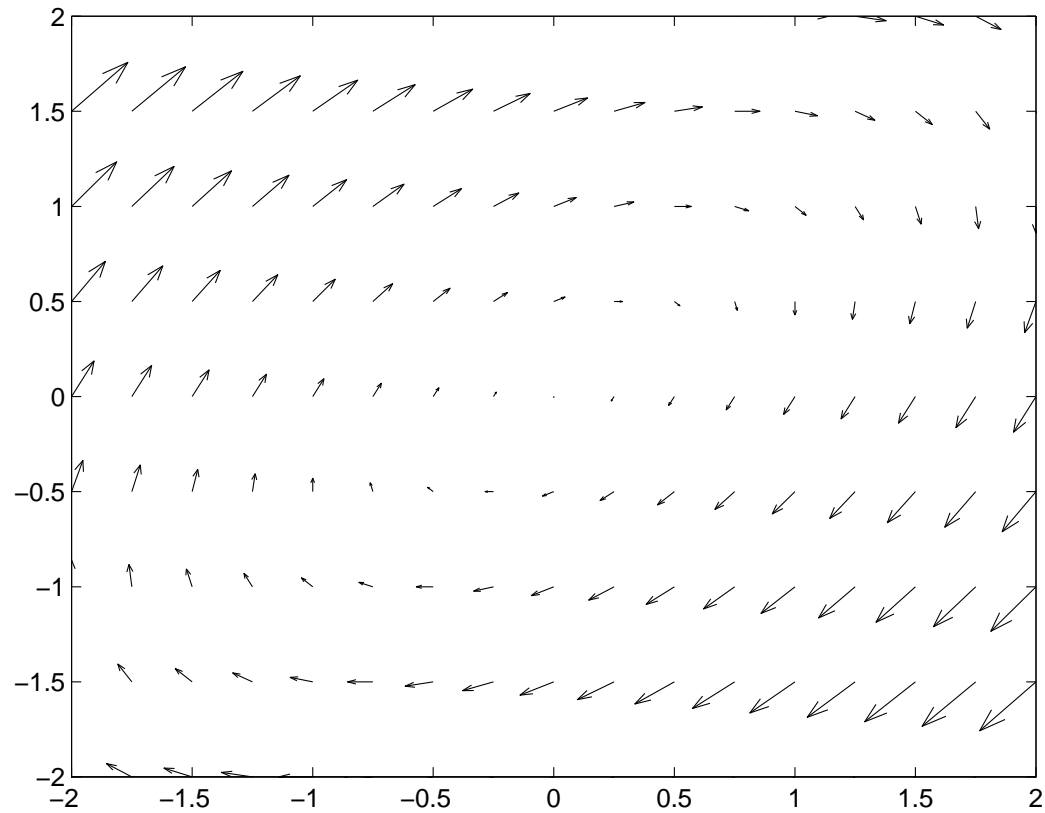

# Block diagram

block diagram representation of  $\dot{x} = Ax$ :

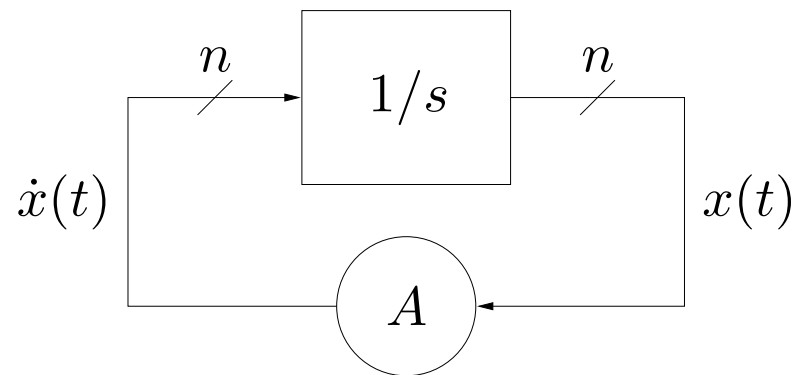

- $1/s$  block represents  $n$  parallel scalar integrators
- coupling comes from dynamics matrix  $A$

useful when  $A$  has structure, *e.g.*, block upper triangular:

$$\dot{x} = \begin{bmatrix} A_{11} & A_{12} \\ 0 & A_{22} \end{bmatrix} x$$

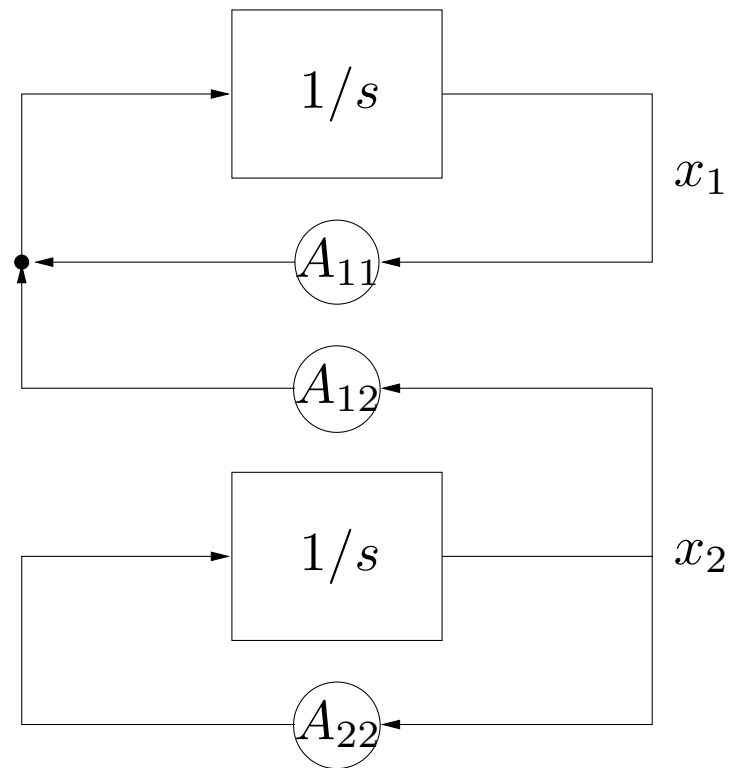

here  $x_1$  doesn't affect  $x_2$  at all

# Linear circuit

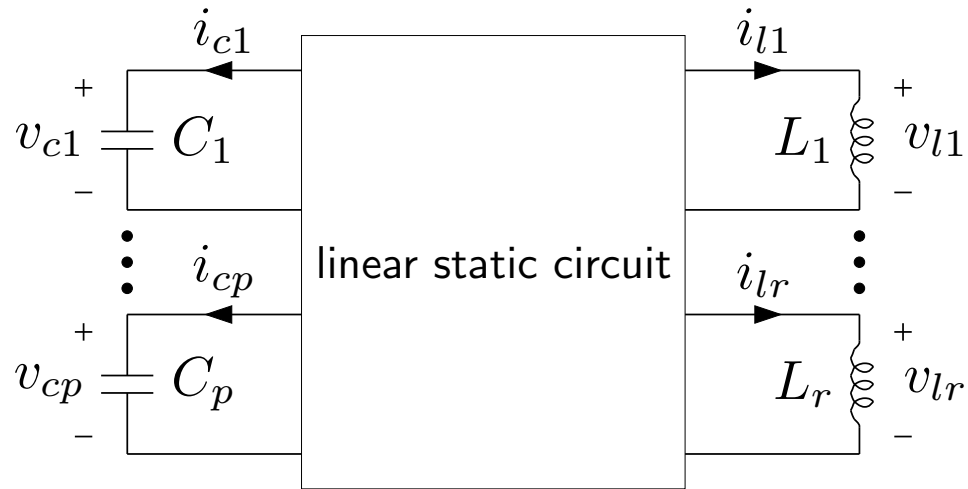

circuit equations are

$$C \frac{dv_c}{dt} = i_c, \quad L \frac{di_l}{dt} = v_l, \quad \begin{bmatrix} i_c \\ v_l \end{bmatrix} = F \begin{bmatrix} v_c \\ i_l \end{bmatrix}$$

$$C = \mathbf{diag}(C_1, \dots, C_p), \quad L = \mathbf{diag}(L_1, \dots, L_r)$$



with state  $x = \begin{bmatrix} v_c \\ i_l \end{bmatrix}$ , we have

$$\dot{x} = \begin{bmatrix} C^{-1} & 0 \\ 0 & L^{-1} \end{bmatrix} Fx$$

# Chemical reactions

- reaction involving  $n$  chemicals;  $x_i$  is concentration of chemical  $i$
- linear model of reaction kinetics

$$\frac{dx_i}{dt} = a_{i1}x_1 + \cdots + a_{in}x_n$$

- good model for some reactions;  $A$  is usually sparse

**Example:** series reaction  $A \xrightarrow{k_1} B \xrightarrow{k_2} C$  with linear dynamics

$$\dot{x} = \begin{bmatrix} -k_1 & 0 & 0 \\ k_1 & -k_2 & 0 \\ 0 & k_2 & 0 \end{bmatrix} x$$

plot for  $k_1 = k_2 = 1$ , initial  $x(0) = (1, 0, 0)$

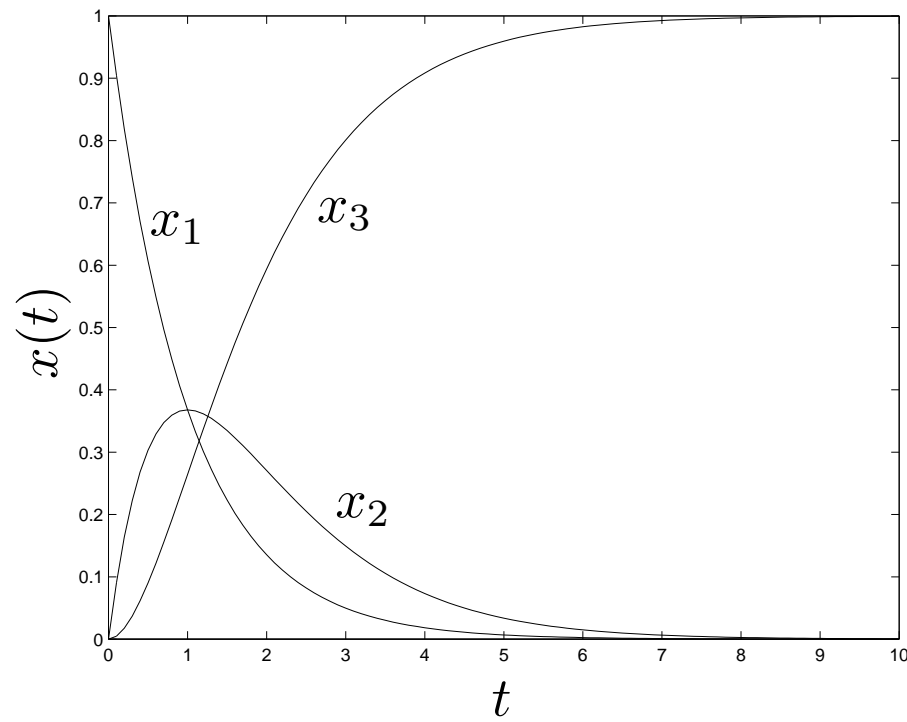

# Finite-state discrete-time Markov chain

$z(t) \in \{1, \dots, n\}$  is a random sequence with

$$\mathbf{Prob}( z(t+1) = i \mid z(t) = j ) = P_{ij}$$

where  $P \in \mathbf{R}^{n \times n}$  is the matrix of *transition probabilities*

can represent probability distribution of  $z(t)$  as  $n$ -vector

$$p(t) = \begin{bmatrix} \mathbf{Prob}(z(t) = 1) \\ \vdots \\ \mathbf{Prob}(z(t) = n) \end{bmatrix}$$

(so, e.g.,  $\mathbf{Prob}(z(t) = 1, 2, \text{ or } 3) = [1 \ 1 \ 1 \ 0 \cdots 0]p(t)$ )

then we have  $p(t+1) = Pp(t)$

$P$  is often sparse; Markov chain is depicted graphically

- nodes are states
- edges show transition probabilities

**example:**

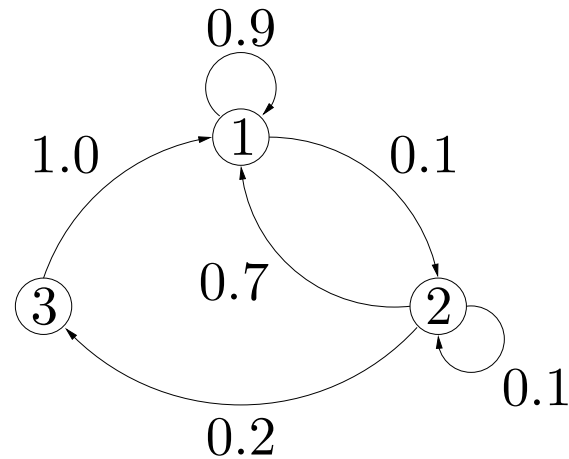

- state 1 is 'system OK'
- state 2 is 'system down'
- state 3 is 'system being repaired'

$$p(t + 1) = \begin{bmatrix} 0.9 & 0.7 & 1.0 \\ 0.1 & 0.1 & 0 \\ 0 & 0.2 & 0 \end{bmatrix} p(t)$$

# Numerical integration of continuous system

compute approximate solution of  $\dot{x} = Ax$ ,  $x(0) = x_0$

suppose  $h$  is small time step ( $x$  doesn't change much in  $h$  seconds)

simple ('forward Euler') approximation:

$$x(t+h) \approx x(t) + h\dot{x}(t) = (I + hA)x(t)$$

by carrying out this recursion (discrete-time LDS), starting at  $x(0) = x_0$ , we get approximation

$$x(kh) \approx (I + hA)^k x(0)$$

(forward Euler is never used in practice)

# Higher order linear dynamical systems

$$x^{(k)} = A_{k-1}x^{(k-1)} + \dots + A_1x^{(1)} + A_0x, \quad x(t) \in \mathbf{R}^n$$

where  $x^{(m)}$  denotes  $m$ th derivative

define new variable  $z = \begin{bmatrix} x \\ x^{(1)} \\ \vdots \\ x^{(k-1)} \end{bmatrix} \in \mathbf{R}^{nk}$ , so

$$\dot{z} = \begin{bmatrix} x^{(1)} \\ \vdots \\ x^{(k)} \end{bmatrix} = \begin{bmatrix} 0 & I & 0 & \dots & 0 \\ 0 & 0 & I & \dots & 0 \\ \vdots & & & & \vdots \\ 0 & 0 & 0 & \dots & I \\ A_0 & A_1 & A_2 & \dots & A_{k-1} \end{bmatrix} z$$

a (first order) LDS (with bigger state)



block diagram:

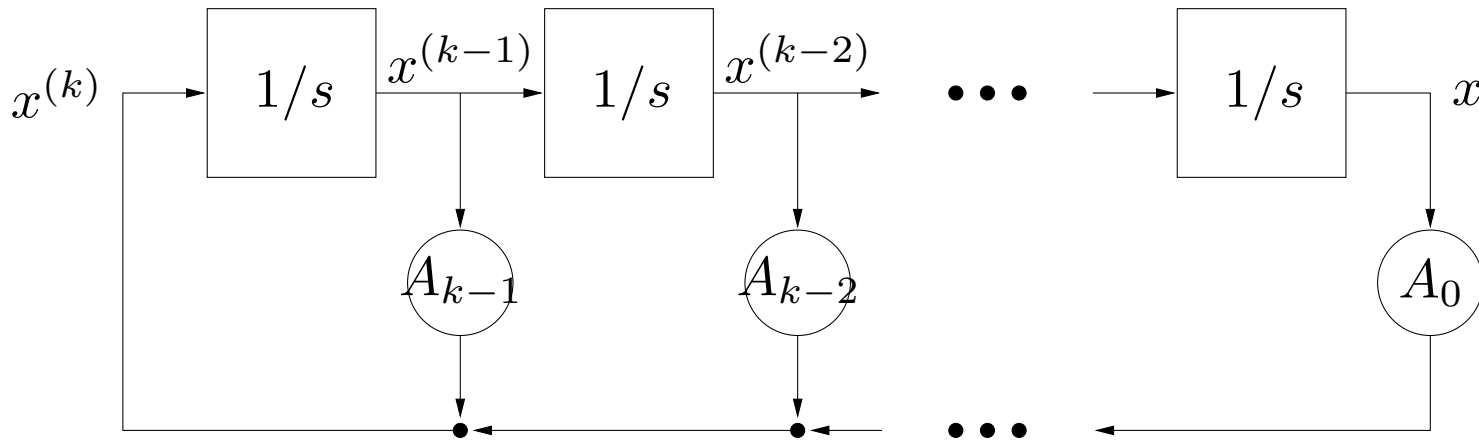

# Mechanical systems

mechanical system with  $k$  degrees of freedom undergoing small motions:

$$M\ddot{q} + D\dot{q} + Kq = 0$$

- $q(t) \in \mathbf{R}^k$  is the vector of generalized displacements
- $M$  is the *mass matrix*
- $K$  is the *stiffness matrix*
- $D$  is the *damping matrix*

with state  $x = \begin{bmatrix} q \\ \dot{q} \end{bmatrix}$  we have

$$\dot{x} = \begin{bmatrix} \dot{q} \\ \ddot{q} \end{bmatrix} = \begin{bmatrix} 0 & I \\ -M^{-1}K & -M^{-1}D \end{bmatrix} x$$

# Linearization near equilibrium point

nonlinear, time-invariant differential equation (DE):

$$\dot{x} = f(x)$$

where  $f : \mathbf{R}^n \rightarrow \mathbf{R}^n$

suppose  $x_e$  is an *equilibrium point*, i.e.,  $f(x_e) = 0$

(so  $x(t) = x_e$  satisfies DE)

now suppose  $x(t)$  is near  $x_e$ , so

$$\dot{x}(t) = f(x(t)) \approx f(x_e) + Df(x_e)(x(t) - x_e)$$

with  $\delta x(t) = x(t) - x_e$ , rewrite as

$$\dot{\delta x}(t) \approx Df(x_e)\delta x(t)$$

replacing  $\approx$  with  $=$  yields *linearized approximation* of DE near  $x_e$

we *hope* solution of  $\dot{\delta x} = Df(x_e)\delta x$  is a good approximation of  $x - x_e$

(more later)

**example:** pendulum

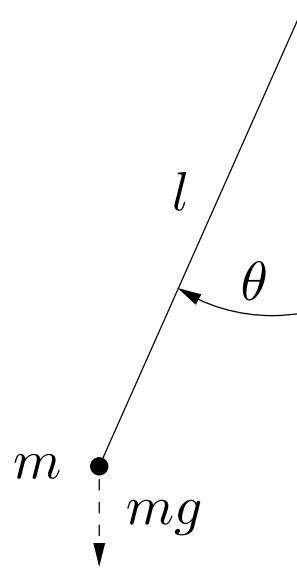

2nd order nonlinear DE  $ml^2\ddot{\theta} = -lmg \sin \theta$

rewrite as first order DE with state  $x = \begin{bmatrix} \theta \\ \dot{\theta} \end{bmatrix}$ :

$$\dot{x} = \begin{bmatrix} x_2 \\ -(g/l) \sin x_1 \end{bmatrix}$$

equilibrium point (pendulum down):  $x = 0$

linearized system near  $x_e = 0$ :

$$\dot{\delta x} = \begin{bmatrix} 0 & 1 \\ -g/l & 0 \end{bmatrix} \delta x$$

## Does linearization 'work'?

the linearized system usually, but not always, gives a good idea of the system behavior near  $x_e$

**example 1:**  $\dot{x} = -x^3$  near  $x_e = 0$

for  $x(0) > 0$  solutions have form  $x(t) = (x(0)^{-2} + 2t)^{-1/2}$

linearized system is  $\dot{\delta x} = 0$ ; solutions are constant

**example 2:**  $\dot{z} = z^3$  near  $z_e = 0$

for  $z(0) > 0$  solutions have form  $z(t) = (z(0)^{-2} - 2t)^{-1/2}$

(finite escape time at  $t = z(0)^{-2}/2$ )

linearized system is  $\dot{\delta z} = 0$ ; solutions are constant

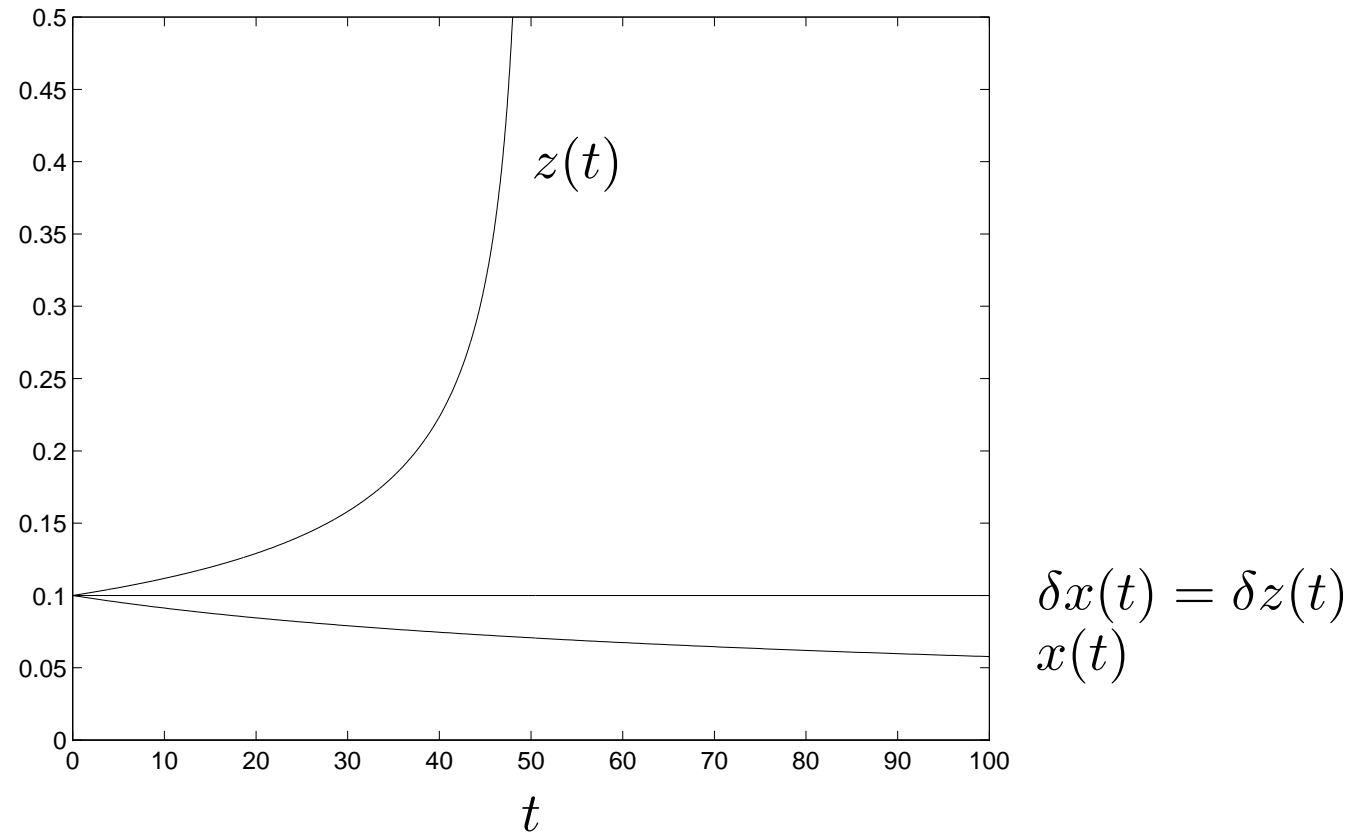

- systems with very different behavior have same linearized system
- linearized systems do not predict qualitative behavior of either system



# Linearization along trajectory

- suppose  $x_{\text{traj}} : \mathbf{R}_+ \rightarrow \mathbf{R}^n$  satisfies  $\dot{x}_{\text{traj}}(t) = f(x_{\text{traj}}(t), t)$
- suppose  $x(t)$  is another trajectory, *i.e.*,  $\dot{x}(t) = f(x(t), t)$ , and is near  $x_{\text{traj}}(t)$
- then

$$\frac{d}{dt}(x - x_{\text{traj}}) = f(x, t) - f(x_{\text{traj}}, t) \approx D_x f(x_{\text{traj}}, t)(x - x_{\text{traj}})$$

- (time-varying) LDS

$$\dot{\delta x} = D_x f(x_{\text{traj}}, t)\delta x$$

is called *linearized* or *variational system* along trajectory  $x_{\text{traj}}$

**example:** linearized oscillator

suppose  $x_{\text{traj}}(t)$  is  $T$ -periodic solution of nonlinear DE:

$$\dot{x}_{\text{traj}}(t) = f(x_{\text{traj}}(t)), \quad x_{\text{traj}}(t + T) = x_{\text{traj}}(t)$$

linearized system is

$$\dot{\delta x} = A(t)\delta x$$

where  $A(t) = Df(x_{\text{traj}}(t))$

$A(t)$  is  $T$ -periodic, so linearized system is called  *$T$ -periodic linear system*.

used to study:

- startup dynamics of clock and oscillator circuits
- effects of power supply and other disturbances on clock behavior